

2SA562TM
Rev.E Mar.-2016

Parameter	Symbol	Rating	Unit
Collector to Base Voltage	V_{CBO}	-35	V

/ Electrical Characteristic Curve

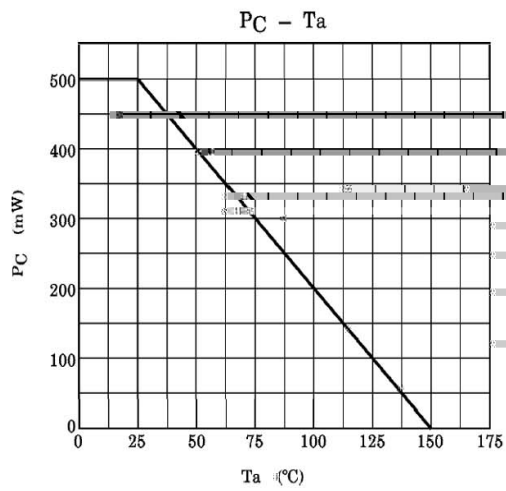
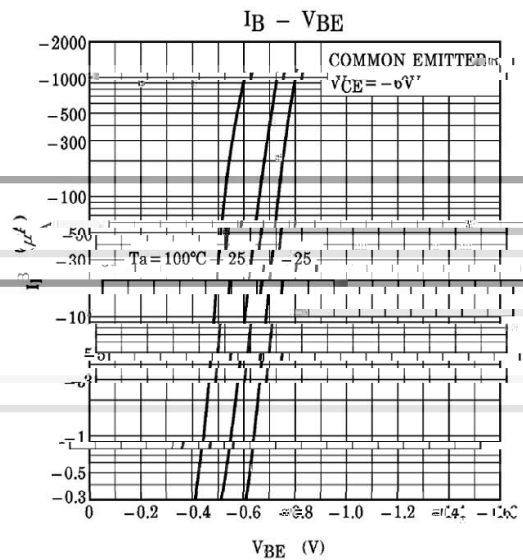
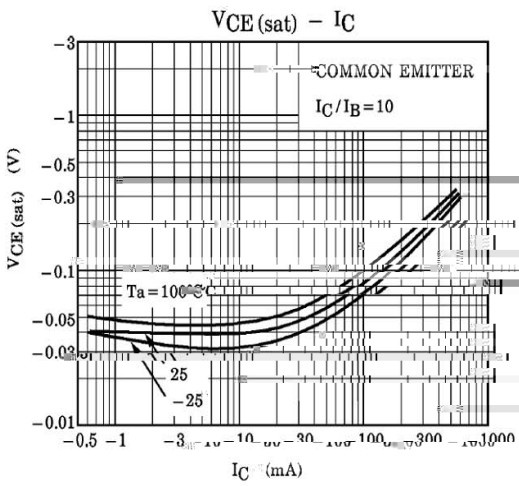
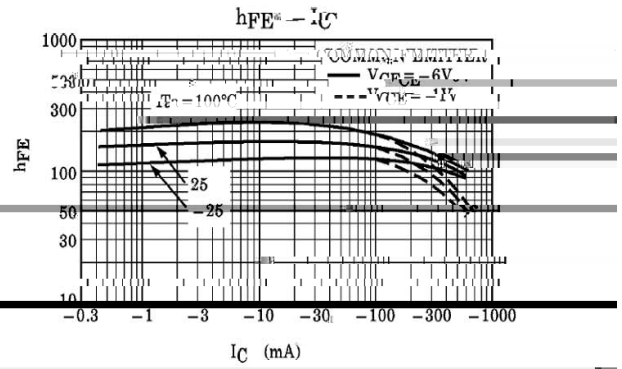
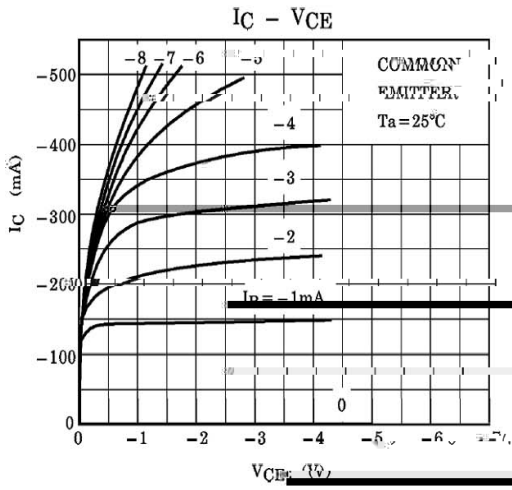

2SA562TM
Rev.E Mar.-2016

/ Marking Instructions

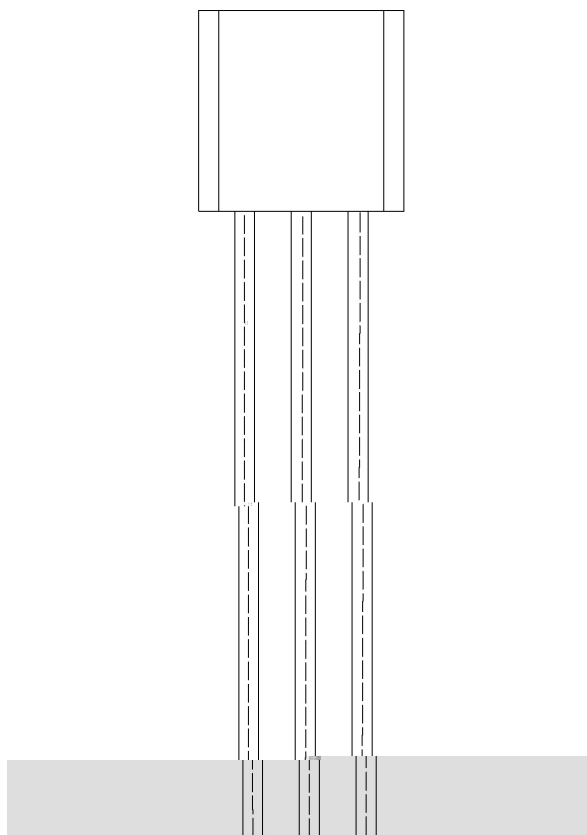

9| 1

8, -)

F 1

h_{FE}

2SA562T

Rev.E Mar.-20

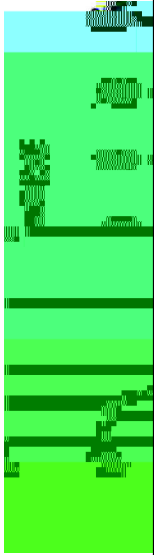

- 1
- 2
- 3