

/ Descriptions

/ Features

AEC-Q101

/ Applications

BMS

/ Equivalent Circuit

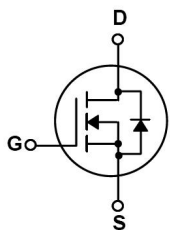

/ Pinning

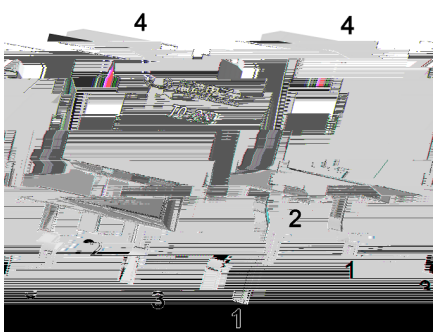

/ Marking

BRCS035N06SHBDQ

/ Electrical Characteristic Curve

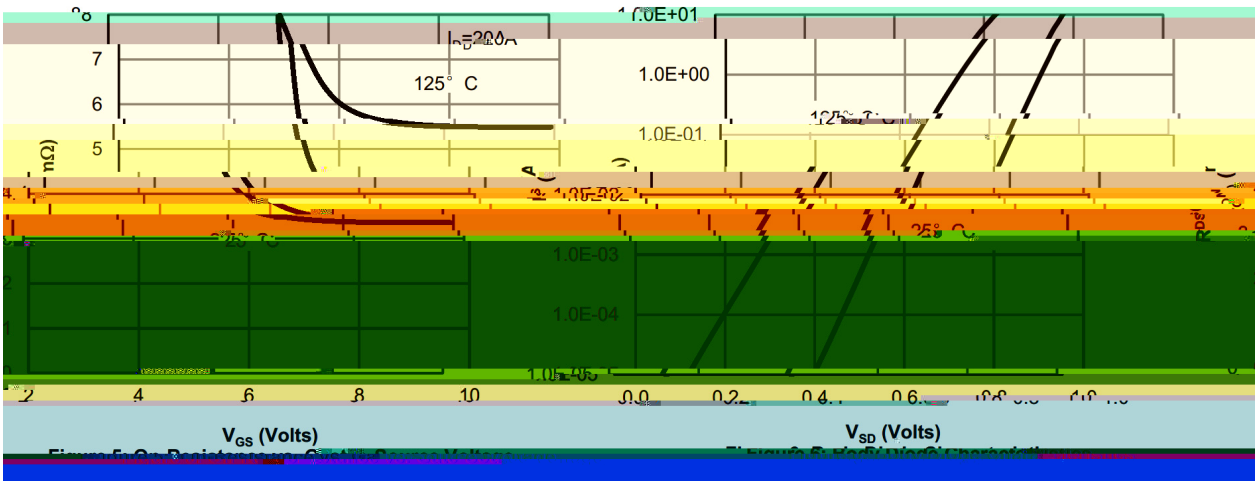
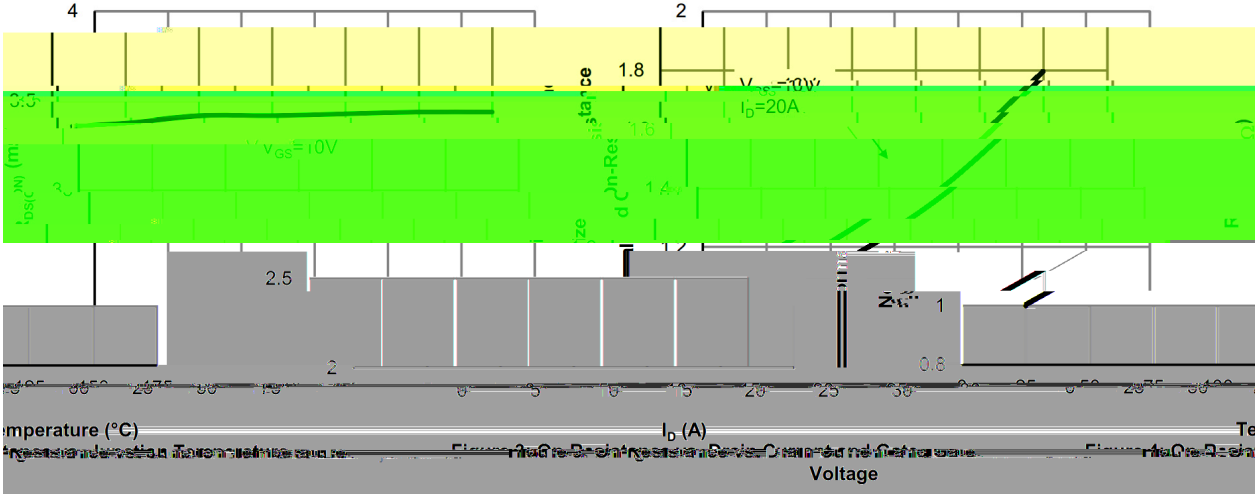
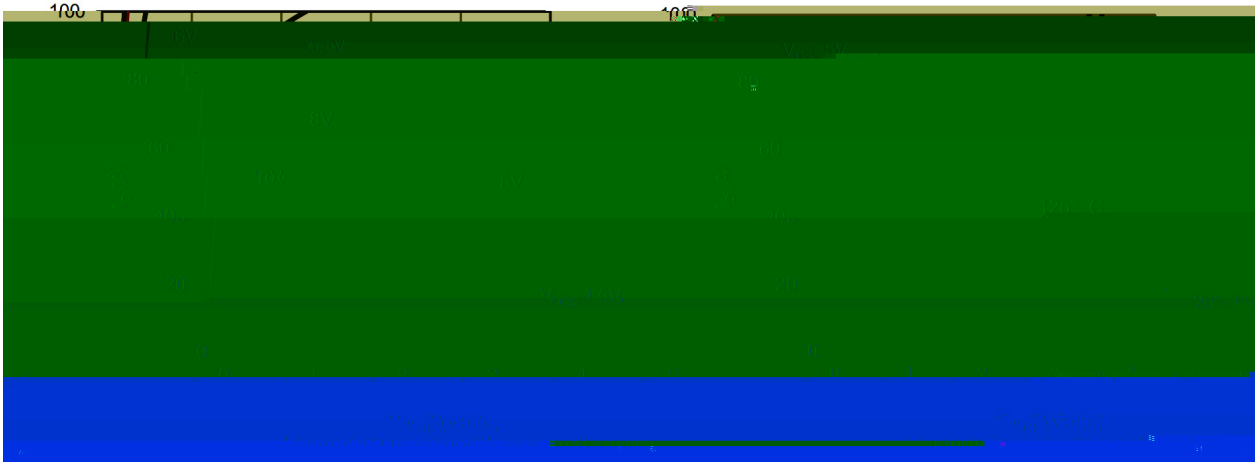

BRCS035N06SHBDQ



DATA SHEET

/ Package Dimensions

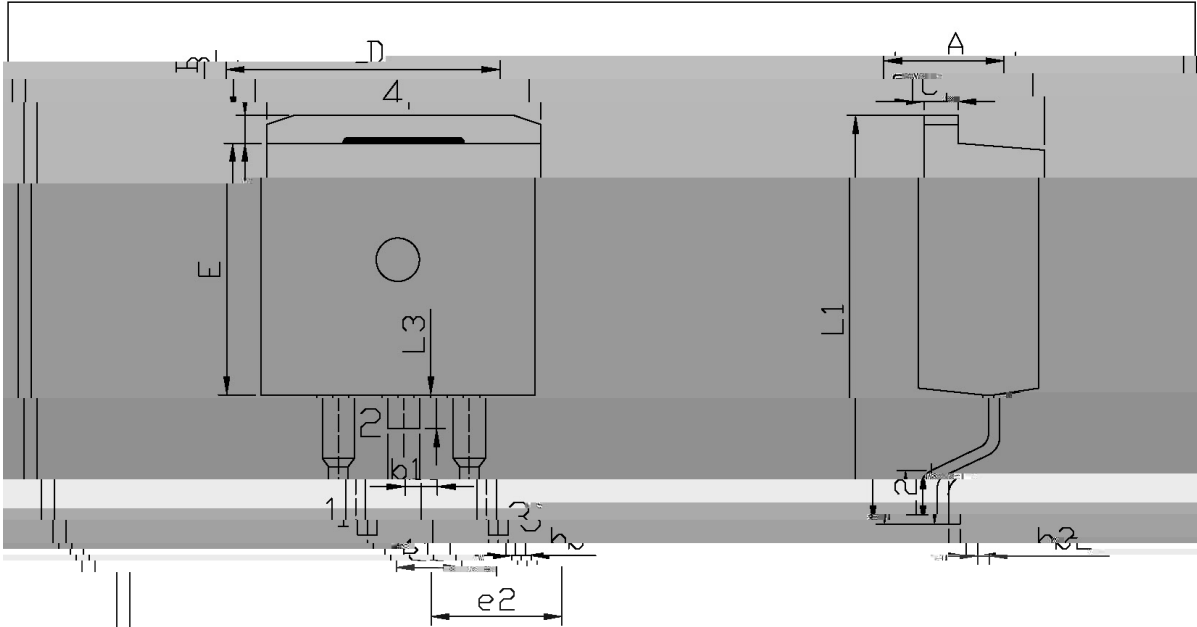

单位: mm

Dimensions		Dimensions In. Millimeters		Dimensions In. Mill.	
Symbol	Min	Max	Symbol	Min	Max
A	4.30	4.70	E	0.90	
B	1.00	1.40	e1	2.54	
C	0.90	1.00	e2	2.54	
D	4.30	4.70	h1	0.90	
E	0.90	1.00	h2	0.90	
L1	1.00	1.40	h3	0.90	
L2	1.00	1.40	h4	0.90	
L3	1.00	1.40			

/ Marking Instructions

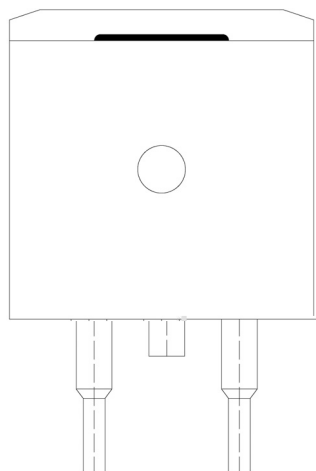

BR

035N06SH

BRCS035N06SHBDQ



DATA SHEET

() / Temperature Profile for IR Reflow Soldering(Pb-Free)