

GBU8005~GBU810

202

8.0A
80

50~1000V GBU

: 0 1000

9 0

9 0

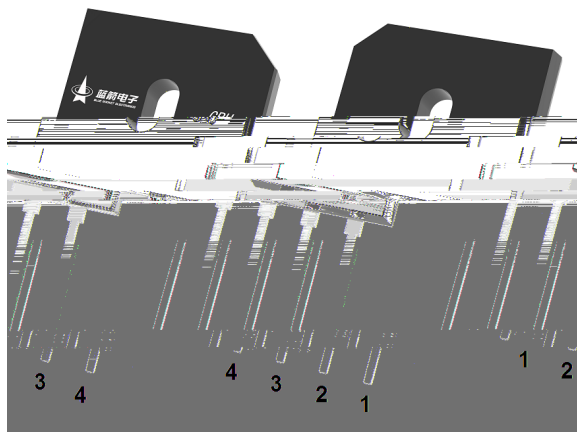
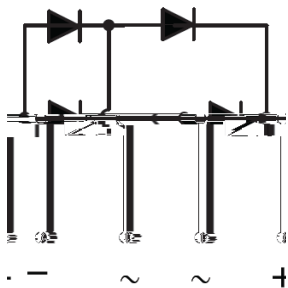

1

2

3

1

:

		800	801	802	80	806	808	810	
		0	100	200	00	600	800	1000	
		3	70	1 0	280	20	60	700	
		0	100	200	00	600	800	1000	
=100 ()	()	8 0							
()		17							

(<8 3)

2

127

2

/ Electrical Characteristic Curve

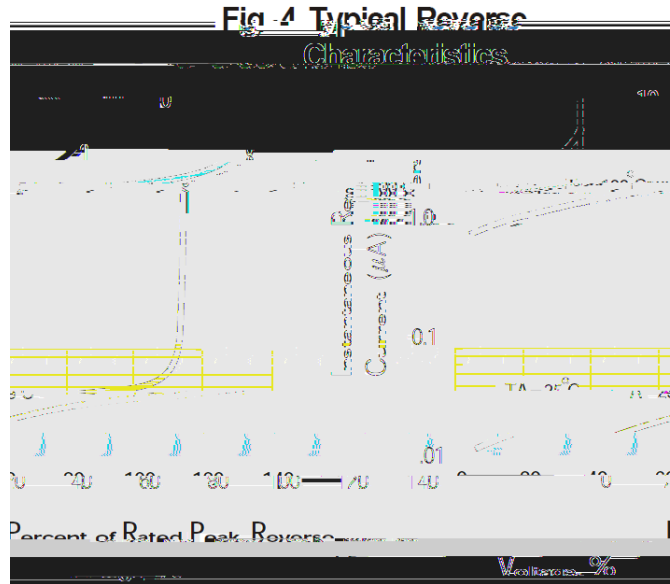
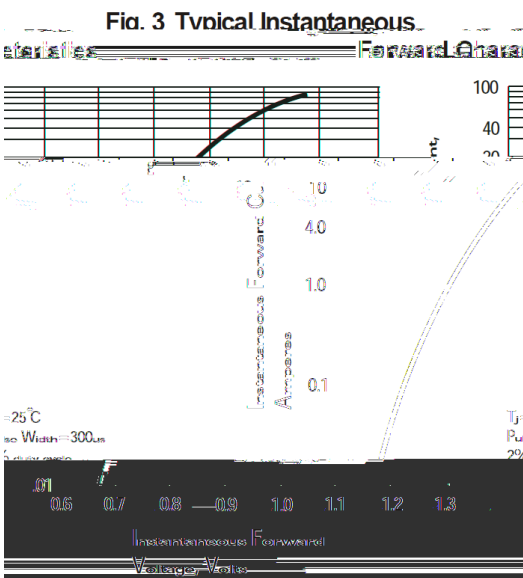
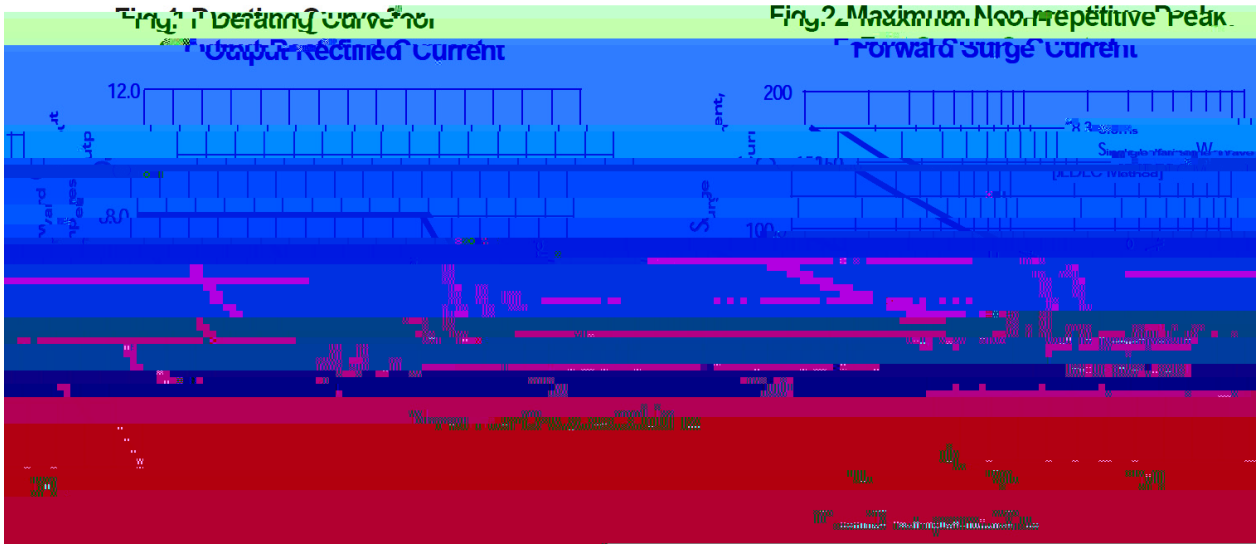
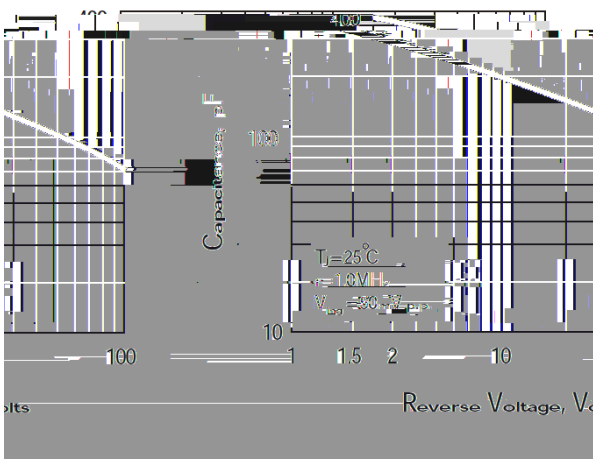
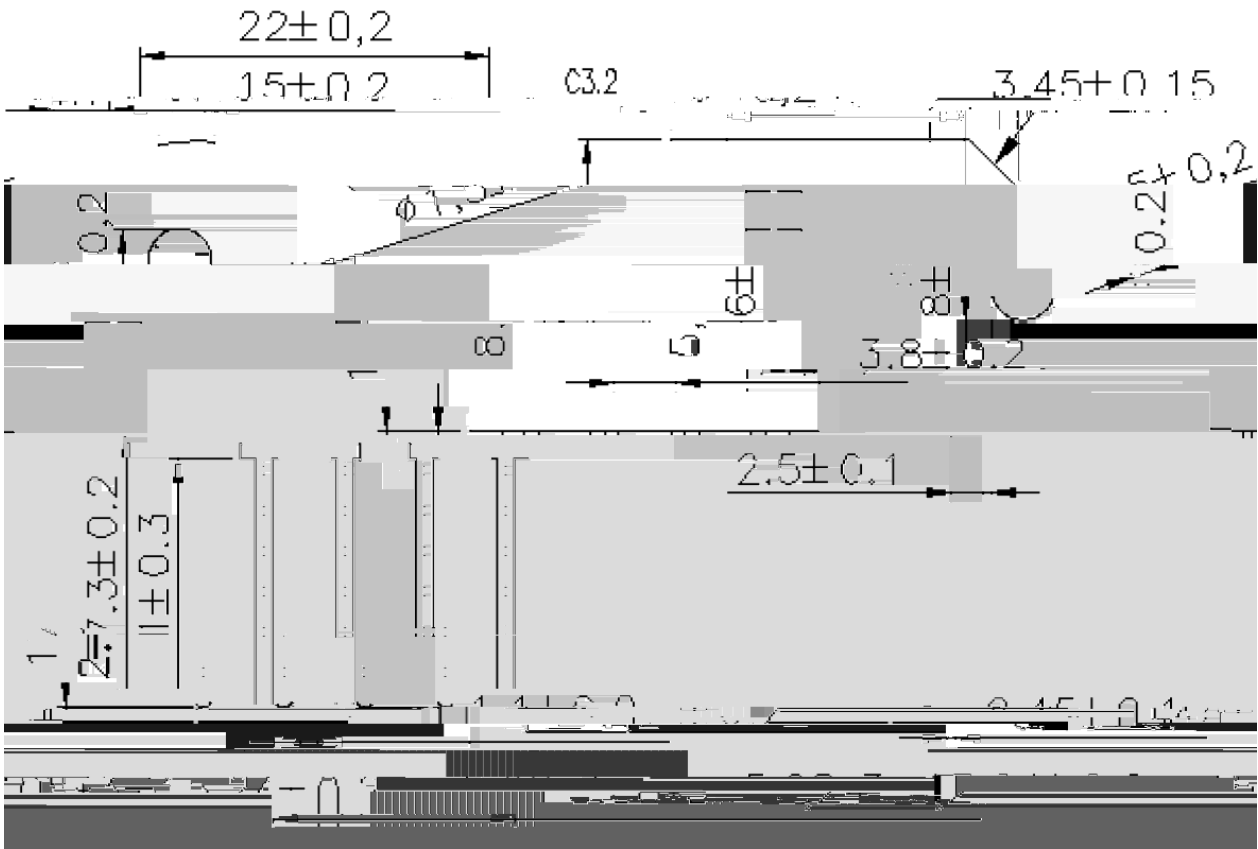

Fig. 5 Typical Junction Capacitance



/ Package Dimensions



/ Marking Instructions

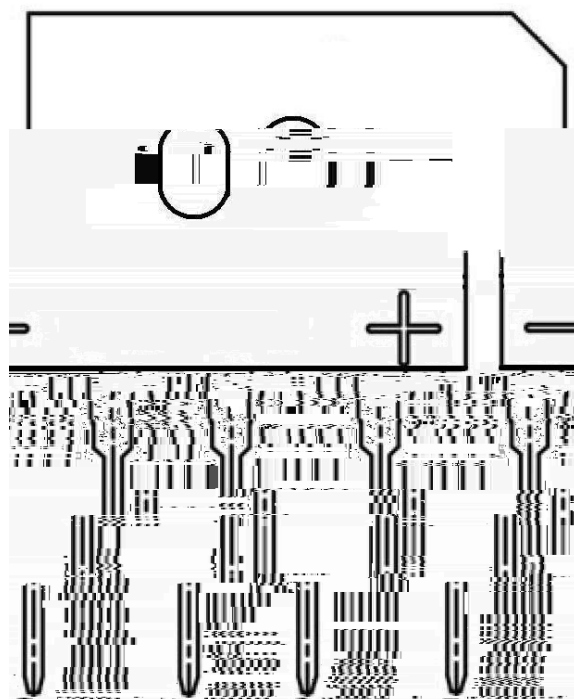

() / Temperature Profile for Dip Soldering(Pb-Free)

1 2 1 0 60 90 ; 1 :2 1 0 :60 90
 2 2 ± ±0 ; 2 :2 ± : ±0
 3 2 10 3 :2 10

/ Resistance to Soldering Heat Test Conditions

270± 10±1 :270 :10 1

/ Packaging SPEC.