

Rev.B Jan-2021

1.2A

MBF

1.2A Surface Mount Glass Passivated Bridge Rectifier, MBF thin package.

Glass Passivated Chip Junction, Reverse Voltage:100to1000V, Forward Current: 1.2A, High Surge Current Capability, Designed for Surface Mount Application.Halogen free product.

General purpose.

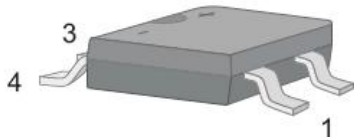
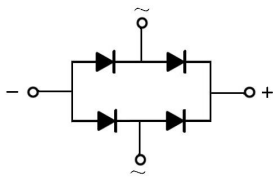

See Marking Instructions.

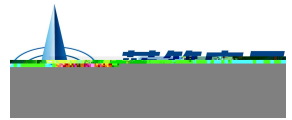

Rev.B Jan-2021



MBF

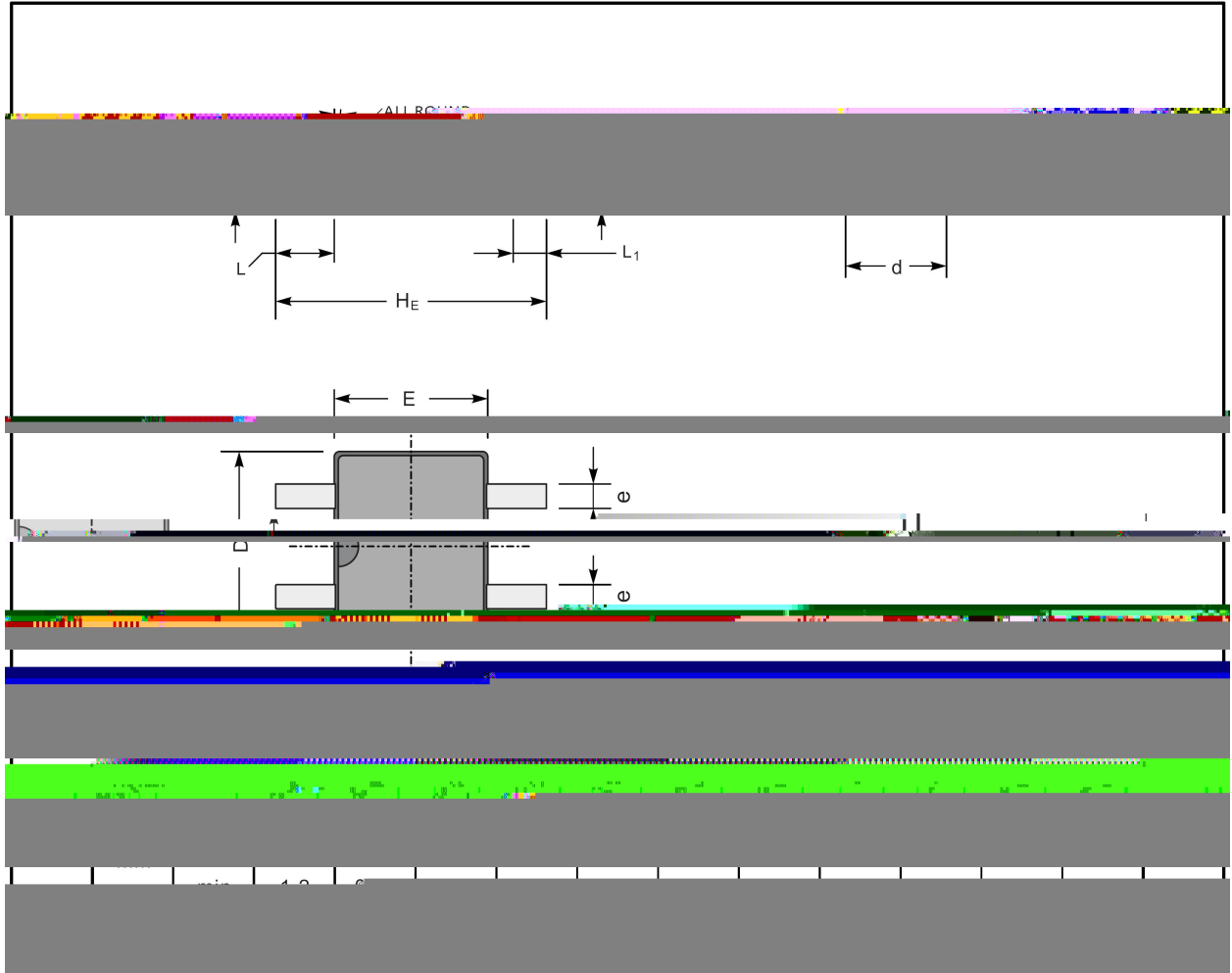

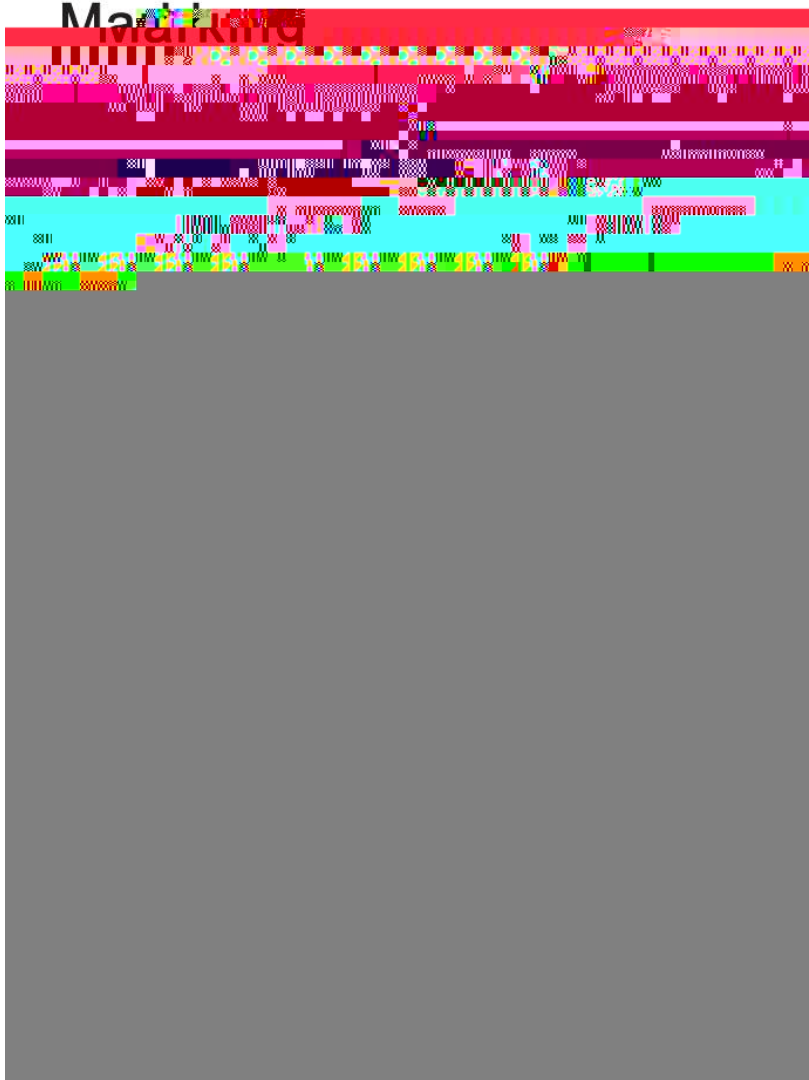
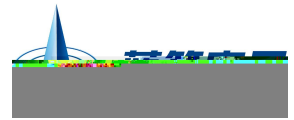

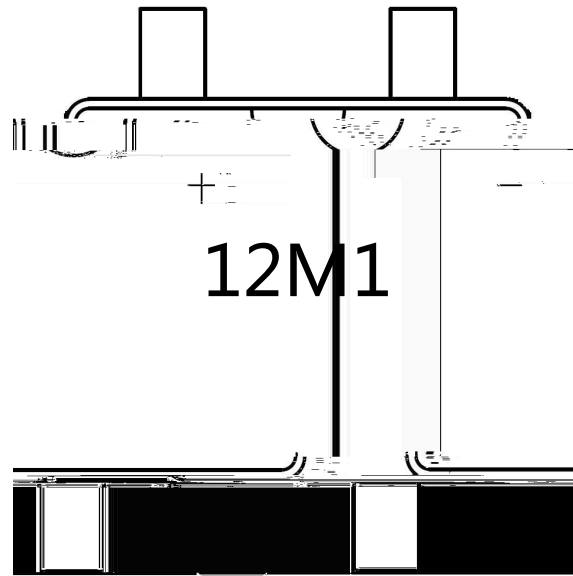
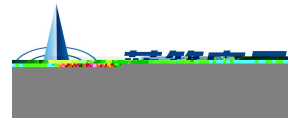

12M1

1 *

3 *

Note:

12M1 Product Type Code

Lot No. Code The 1st * means:YM Code The last 3 * means:little Lot No Code

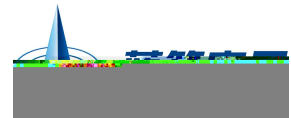

Temperature Profile for IR Reflow Soldering(Pb-Free)

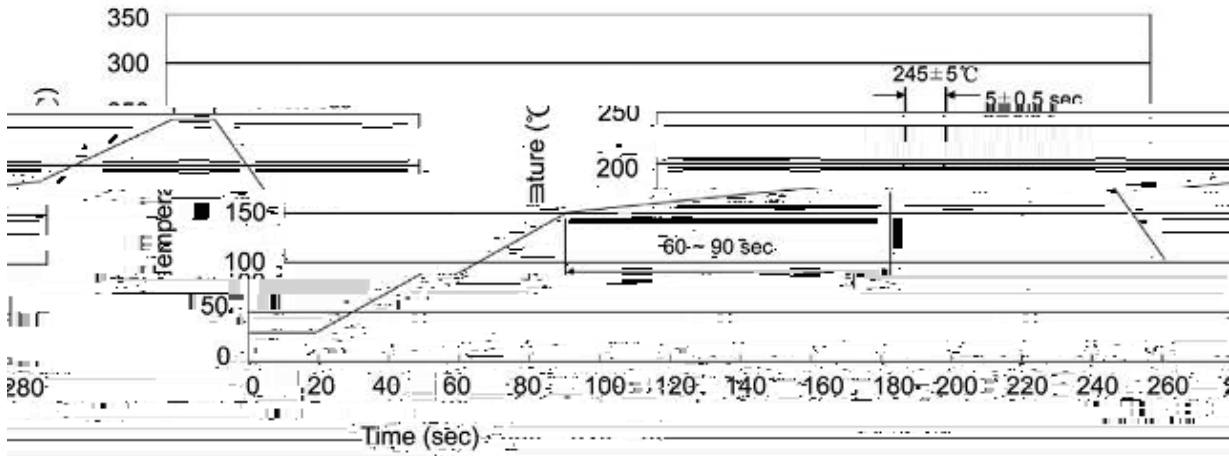

- :
- 1、预温 150 180 60 90sec;
 - 2、 温 245±5 5±0.5sec;
 - 3、

- Note:
- 1.Preheating:150~180°C, Time:60~90sec.
 - 2.Peak Temp.:245±5°C, Duration:5±0.5sec.